

# 矽科電子



矽科電子

**RF ICs**



*Low RX Current*



## 關於笙科電子

笙科電子 (AMICCOM) 是一間專業的 RF 晶片設計公司，管理階層和技術團隊均已在 RF 業界數十年的經驗。笙科一直專注研發 CMOS 製程的 RF 半導體晶片，提供客戶高性能、低成本、高整合度的 RF IC 與 SOC。笙科電子產品的應用範圍非常廣泛，在 PC 應用方面，如：無線滑鼠 / 鍵盤 / Vista RF 遙控器，以及 Wireless USB。在工業應用方面，如：自動讀表系統 (AMR/AMI)、Zigbee、WiSUN、智慧型建築，以及工廠自動化控制。在消費電子應用方面，如：低功耗藍芽 (Bluetooth LE)、電子貨價標籤 (ESL)、PS / Xbox 無線遊戲控制器、無線耳機以及無線對講機。在汽車電子應用方面，如：汽車遙控器、汽車防盜系統、無線胎壓偵測，以及無線倒車影像系統。加上特殊的無線應用，如：衛星通訊接收器、智慧型運動器材、以及無線醫療儀器。以上各式應用，均已為笙科電子積極開發的市場。同時，我們的管理團隊秉持藍海策略，我們的技術團隊持續開發自我專利的 CMOS RF IC，期盼帶給人類更好的生活經驗。

## 关于笙科电子

笙科电子 (AMICCOM) 是一间专业的 RF 芯片设计公司，管理阶层和技术团队均已在 RF 业界数十年的经验。笙科一直专注研发 CMOS 制程的 RF 半导体芯片，提供客户高性能、低成本、高整合度的 RF IC 与 SOC。笙科电子产品的应用范围非常广泛，在 PC 应用方面，如：无线鼠标 / 键盘 / Vista RF 遥控器，以及 Wireless USB。在工业应用方面，如：自动读表系统 (AMR/AMI)、Zigbee、WiSUN、智能型建筑，以及工厂自动化控制。在消费电子应用方面，如：低功耗蓝芽 (Bluetooth LE)、电子货价卷标 (ESL)、PS / Xbox 无线游戏控制器、无线耳机以及无线对讲机。在汽车电子应用方面，如：汽车遥控器、汽车防盗系统、无线胎压侦测，以及无线倒车影像系统。加上特殊的无线应用，如：卫星通讯接收器、智能型运动器材、以及无线医疗仪器。以上各式应用，均已为笙科电子积极开发的市場。同时，我们的管理团队秉持蓝海策略，我们的技术团队持续开发自我专利的 CMOS RF IC，期盼带给人类更好的生活经验。

## About AMICCOM

AMICCOM is a professional semiconductor company offering a complete product family of industry-leading RF ICs. Our management team and technical groups have already stayed in RF field for decades. We definitely focus on RFCMOS process to provide our customers the high performance, low cost, and high integration RF ICs and SOC. In PC applications, we have Wireless Mice/Keyboard/Vista Remote controller and Wireless USB products. In Industrial applications, there are products for AMR/AMI, Zigbee, WiSUN, Smart Building and Automation Control. In Consumer Electronics, we provide chips for Bluetooth LE, Electronic Shelf Label, PS/Xbox Wireless Game Pads, wireless headphone and Walkie Talkie application. In Automotive Electronics, we have products for Car Remote Controller, Car Security, TPMS and Wireless Video Parking System. We also engaged in some Specific applications, such as Satellite LNB, Intelligent Sports and Wireless Medicine. Those markets are what AMICCOM have dedicated to. Our management team always focuses on Blue Ocean Strategy and our technical groups keep developing the advanced RF IC/SOC to bring better life experiences to human beings.

笙科電子專注以 CMOS 技術設計 RF IC，從元件佈局，功耗最小化，獨特的電路設計加上先進的製程，笙科電子所設計的高頻特性已超越商用化的水準。笙科電子根據 ISM Band 無線應用，提供客戶三大選擇；2.4GHz, Sub 1GHz(169/315/433/868/915MHz) 與 5.8GHz，完整的產品線包含：單向 / 雙向 RF IC；多種傳輸速率 2K~500K / 500K ~2M/3M/4M/6M bps；可程式化發射功率 -10 ~ + 20dBm，配合高接收靈敏度，並可依需求外掛笙科的 LNA/PA 或內建的 PA，符合客戶設計遠近不同 (1m ~ 1.0km) 的無線應用。

AMICCOM focuses on RF IC/SOC design with CMOS technology. From device layout, power optimization, circuit design, and advanced semiconductor processes, AMICCOM's high-frequency circuit characteristics have surpassed commercial standards. AMICCOM provides customers three ISM Band wireless applications: 2.4GHz, Sub 1GHz (169/315/433/868/915MHz), and 5.8GHz. The complete product lines include: unidirectional/bidirectional RF IC and SOC; various transmission speeds: 0.25K ~ 500K/500K ~ 2M/3M/4M/6M bps; Programmable transmitting power level: -10 ~ + 20dBm with high receiving sensitivity. According to transmission distance requirements (1M ~ 1.0KM), customer also can choose to use AMICCOM's LNA/PA or built-in PA for wireless applications.

笙科電子設計的 RF IC 採用高整合概念，晶片內建 VCO、PLL、LNA、PA、FIFO、RSSI、CRC、FEC、Data Whitening (可視為資料加密)、Auto Calibration 等功能，使用者可自行選擇熟悉的 MCU 透過 SPI 介面控制 RF IC，笙科電子的 RF IC 對於 MCU 並沒有挑剔性，RF IC 與 MCU 之間均為數位介面，易於開發與除錯，配合笙科電子提供的參考代碼及開發套件，研發時不需要艱深的射頻知識，生產時也不需要昂貴的射頻儀器，RF 模組僅需少量的外部元件，即可輕易地開發各式各樣的無線應用。除了 RF IC 外，笙科電子並積極開發高整合的 SoC 產品，內建 8bit CPU (1T 8051)，ARM Cortex M0 或 M4，各種數位周邊 (UART、I2C、SPI、PWM) 及 Audio Codec，可適用於各種無線應用。



The RF ICs provided by AMICCOM are highly integrated chips. These chips build in VCO, PLL, LNA, PA, FIFO, RSSI, CRC, FEC, Data Whitening, Auto Calibration and many other functions. Users can choose Various MCUs to control the RF IC through the SPI interface. Through the digital interface of RF IC and MCU, it is easy to develop and debug system for customer. In conjunction with the reference code and development kit provided by AMICCOM, customers don't need to know the hard RF knowledge during development and no need for expensive RF equipment during mass-production. RF modules only need a few external components and it is easy to develop all kind of wireless application with chips provided by AMICCOM. In addition to RF ICs, AMICCOM also provide customers the highly integrated SOC products with embedded micro-controller (including 8bit 1T-8051, 32-bit ARM Cortex-M0 and M4F), various digital peripherals (UART, I2C, SPI, PWM) and audio codec. Those SOC product lines are suitable for a variety of wireless applications.

## 2.4GHz Proprietary TRX

PART NUMBER	Type	MODULATION	DATA RATE (kbps)	SENSITIVITY (dBm)	RX CURRENT (mA)	OUTPUT POWER (Max dBm)	TX CURRENT(dBm)				Package
							0	+5	+10	Max. mA	
A7157	TRX	DSSS	133.3 - 66.6	-100@133.3Kbps	65	+17				99	QFN 32
A7196	TRX	FSK/GFSK	6000 - 4000	-83@6Mbps	29	+19.5				140	QFN 24
A7192	TRX	FSK/GFSK	2000 - 500	-89@2Mbps	23	+19.5				140	QFN 24
A7131	TRX	FSK/GFSK	4000 - 2000	-88@4Mbps	27	+10			35		QFN 20
A7130	TRX	FSK/GFSK	4000 - 2000	-88@4Mbps	27	+5	20	29			QFN 20
A7121	TRX	FSK/GFSK	3000	-80@3Mbps	28	+0	34				QFN 32
A7137	TRX	FSK/GFSK	2000 - 500	-90@2Mbps	24	+10	23.5		35.5		QFN 20
A7125	TRX	FSK	2000 - 500	-90@2Mbps	17	+5	16	23			QFN 20
A7325	TX	FSK/GFSK	2000 - 2	-	-	+5	14.5	16.5			QFN 16
A7205	RX	FSK/GFSK	500 - 2	-95@500Kbps	16	-	-	-	-	-	QFN 20
A7105	TRX	FSK/GFSK	500 - 2	-95@500Kbps	16	+0	20				QFN 20

## PA / LNA

PART NUMBER	Type	FREQUENCY (MHZ)	SLEEP CURRENT (uA)	RX CURRENT (mA)	OUTPUT POWER (Max dBm)	TX CURRENT (mA)	Package
A7700	PA/LNA	2400 - 2483.5	1	4.3	+19	115@19dBm	QFN 16
A7701	PA/LNA	2400 - 2483.5	1	5.4	+23	220@22dBm	QFN 16



2.4GHz module

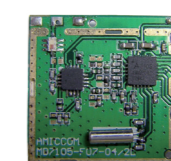

2.4GHz + A7700 module.

## 2.4GHz SoC

PART NUMBER	Type	Code Memory	RAM	Digital I/O	Peripheral	ADC	MODULATION	DATA RATE (kbps)	SENSITIVITY (dBm)	RX CURRENT (mA)	OUTPUT POWER (Max dBm)	TX CURRENT(dBm)			Package
												+0	+5	+10	
A8137M0	2.4GHz 13dBm TRX SoC														
A81C37F7101AQ5A	ARM® Cortex®-M0	128 KB Flash	32KB	23	I2C, SPIx3, UARTx3, PWMx7	7Ch, 12bit ; RSSI, 8bit	FSK	2000 - 4	-90@2Mbps	19.5	+13			57.1 @13dBm	QFN 40
A8125M0	2.4GHz low power TRX SoC														
A81U25F7101AQ5A	ARM® Cortex®-M0	128 KB Flash	32KB	23	I2C, SPIx2, UARTx3, PWMx7, NFC	7Ch, 12bit ; RSSI, 8bit	FSK/GFSK	2000 - 8	-90@2Mbps	7.1@DC/DC	+5		9.0@DC/DC		QFN 40
A8131M0	2.4GHz low power TRX SoC														
A81C31F7100AQ5A	ARM® Cortex®-M0	128 KB Flash	32KB	23	I2C, SPIx3, UARTx3, PWMx7	7Ch, 12bit ; RSSI, 8bit	FSK	2000 - 250	-90@2Mbps	8.3@DC/DC	+5		10.3@DC/DC		QFN 40
A81C31F8100AQ5A	ARM® Cortex®-M0	256KB Flash	32KB	23	I2C, SPIx3, UARTx3, PWMx7	7Ch, 12bit ; RSSI, 8bit	FSK	2000 - 250	-90@2Mbps	8.3@DC/DC	+5		10.3@DC/DC		QFN 40
A8106M0	2.4GHz low power TRX SoC with NFC														
A81C06F8100AQ5A	ARM® Cortex®-M0	256 KB Flash	32KB	23	I2C, SPIx3, UARTx3, PWMx7	7Ch, 12bit ; RSSI, 8bit	FSK	2000 - 4	-100@500Kbps	6@DC/DC	+5		8@DC/DC		QFN 40
A81C06F8100AQ48	ARM® Cortex®-M0	128 KB Flash	32KB	14	I2C, SPIx2, UARTx3, PWMx5	5Ch, 12bit ; RSSI, 8bit	FSK	2000 - 4	-100@500Kbps	6@DC/DC	+5		8@DC/DC		QFN 32
A8125	2.4GHz TRX SoC														
A81X25F4000AQ5A	8051 CPU	16 KB Flash	256B	24	I2C, SPI, UART, PWMx2	4Ch, 8bit ; RSSI, 8bit	FSK/GFSK	2000 - 8	-90@2Mbps	20.9	+5		21.9		QFN 40
A81X25F4005AQ58	8051 CPU	16 KB Flash	256B	17	I2C, SPI, UART, PWMx1	2Ch, 8bit ; RSSI, 8bit	FSK/GFSK	2000 - 8	-90@2Mbps	20.9	+5		21.9		QFN 32
A8106	2.4GHz TRX SoC														
A81X06F4001AQ5A	8051 CPU	16 KB Flash	2KB	24	I2C, SPI, UART, PWMx2	8Ch, 12bit ; RSSI, 8bit	FSK/GFSK	500 - 5	-99@500Kbps	14	+5	15.3	21.3@4dBm		QFN 40
A8325	2.4GHz TX SoC														
A83X25F400AAQ45	8051 CPU	16KB Flash	1KB	8	UART, PWMx2	2Ch, 12bit ; RSSI, 8bit	FSK/GFSK	2000 - 4			+6		16.2@6dBm		QFN 20

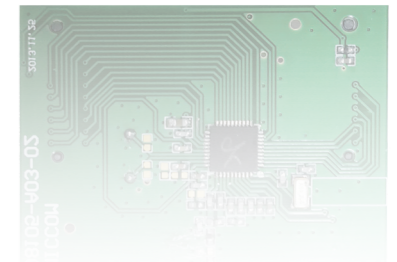
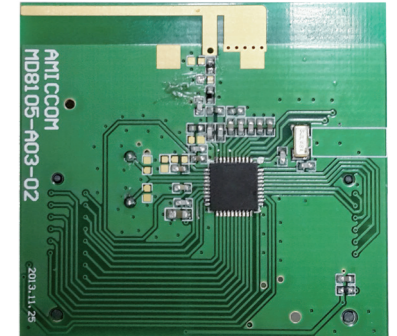

2.4GHz SoC module.

## Sub1GHz Proprietary TRX

PART NUMBER	Type	MODULATION	FREQUENCY (MHZ)	DATA RATE (kbps)	SENSITIVITY (dBm)	RX CURRENT (mA)	OUTPUT POWER (Max dBm)	TX CURRENT(dBm)				Package	
								+5	+10	+15	+20		
A7128	TRX	FSK/GFSK	433 - 915	2000 - 100	-88@2Mbps	18.5	+10		36				QFN 20
A7108	TRX	FSK/GFSK	315 - 915	250 - 2	-117@2Kbps	14	+17					70@17dBm	QFN 20
A7146	TRX	FSK/GFSK IEEE 802.15.4 compliant MAC	169 - 915	1000 - 0.25	-97@500Kbps -127@0.5Kbps	8.2@DC/DC	+20					79.5@19.4dBm,DC/DC	QFN 24
A7136	TRX	4FSK/FSK/ GFSK/4GFSK/OOK	169 - 915	1000 - 0.25	-97@500Kbps -127@0.5Kbps	8.2@DC/DC	+20					79.5@19.4dBm,DC/DC	QFN 24
A7169	TRX	FSK/GFSK	315 - 915	500 - 2	-108@100Kbps	3.3	+20					70@19.1dBm	QFN 16
A7159	TRX	DSSS	315 - 915	250 - 2	-120@10Kcps@DSSS	3.9	+20					86@20dBm	QFN 24
A7119	TRX	DSSS	315 - 915	250 - 2	-120@10Kcps@DSSS	3.9	12.5		25@10dBm				QFN 24
A7149	TRX	FSK/GFSK	315 - 915	250 - 2	-120@2Kbps	1.65	+20					80.8@20.6dBm	QFN 32
A7139	TRX	FSK/GFSK	315 - 915	250 - 2	-120@2Kbps	3.8	+20					77@19dBm	QFN 24
A7109	TRX	FSK/GFSK	315 - 915	250 - 2	-118@2Kbps	1.73	+13			21.5@12.8dBm			QFN 32
A7129	TRX	FSK/GFSK	315 - 915	250 - 2	-119@2Kbps	3.8	+13			28@13dBm			QFN 24
A7112	TRX	FSK/GFSK	315 - 915	250 - 2	-117@2Kbps	13	+13			40@13dBm			QFN 32
A7102	TRX	FSK	315 - 915	150 - 2	-117@2Kbps	13	+15			40			QFN 32
A7103	TRX	FSK/ASK	315 - 915	10 - 1	-110@2.4Kbps	9	+10		18				SSOP 24
A7339	TX	FSK/GFSK	433 - 915	250 - 2	-	-	+20					73@18.8dBm	QFN 20
A7329	TX	FSK/GFSK	433 - 915	250 - 2	-	-	+10		22				QFN 20
A7229	RX	FSK	315 - 915	250 - 2	-114@10Kbps	4	-	-	-	-	-	-	QFN 20
A7209	RX	ASK/OOK	315 - 915	50 - 1	-112@2.4Kbps	4	-	-	-	-	-	-	QFN 20
A7210	RX	ASK/OOK with decoder	315 - 915	5 - 1	-112@2.4Kbps	4	-	-	-	-	-	-	QFN 32
A7302	TX	FSK/ASK	315 - 915	10 - 1	-	-	+11		14@11dBm				DFN 10

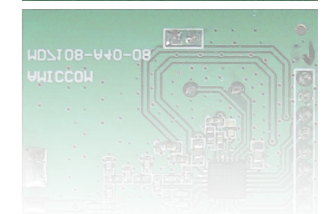
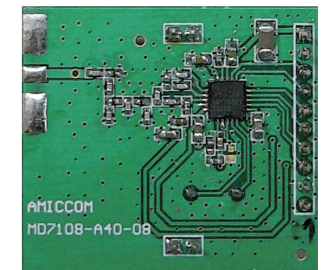

Sub1GHz module.

## Sub1GHz SoC

PART NUMBER	Type	Code Memory	RAM	Digital I/O	Peripheral	ADC	MODULATION	FREQUENCY (MHZ)	DATA RATE (kbps)	SENSITIVITY (dBm)	RX CURRENT (mA)	OUTPUT POWER (Max dBm)	TX CURRENT(dBm)				Package
													+5	+10	+15	+20	
A9108	Sub1GHz TRX																
A91X08F4001AQ5A	8051 CPU	16 KB Flash	2KB	24	I2C, SPI, UART, PWMx2	4Ch, 12bit ; RSSI, 8bit	FSK/GFSK	315 - 915	250 - 2	-117@2Kbps	14.2	+20				81.6@17.4dBm	QFN 40
A9112	Sub1GHz TRX																
A91X12F4001AQ5A	8051 CPU	16 KB Flash	2KB	24	I2C, SPI, UART, PWMx2	4Ch, 12bit ; RSSI, 8bit	FSK/GFSK	315 - 915	250 - 2	-117@2Kbps	13.1	+15			51.2@15.5dBm		QFN 40
A9159	Sub1GHz DSSS TRX																
A91U59F6001AQ6C	8051 CPU	64 KB Flash	8KB	32	I2C, SPI, UARTx2, PWMx4	8Ch, 12bit ; RSSI, 8bit	FSK/GFSK/DSSS	315 - 915	500 - 2	-108@100Kbps	6.9	+20				88.6@19.9dBm	QFN 48
A91X59F4001AQ6C	8051 CPU	16 KB Flash	4KB	32	I2C, SPI, UART, PWMx2	8Ch, 12bit ; RSSI, 8bit	FSK/GFSK/DSSS	315 - 915	250 - 2	-119@10Kcps @DSSS	4.5	+20				72.3@19dBm	QFN 48
A91U59F710NAQ5A	ARM® Cortex®-M0	128 KB Flash	16KB	22	I2C, SPI, UARTx2, PWMx2	8Ch, 12bit ; RSSI, 8bit	FSK/GFSK/DSSS	315 - 915	2000 - 2	-119@10Kcps @DSSS	4.5@DC/DC	+20				69@20dBm, DC/DC	QFN 40
A9146M4	Sub1GHz TRX, IEEE 802.15.4 compliant MAC																
A91S46F920PAQ8G	ARM® Cortex®-M4	512 KB Flash	80KB	21	I2C, SPI, UARTx3, PWMx8	8Ch, 12bit ; RSSI, 8bit	4FSK/FSK/GFSK/4GFSK/OOK	169 - 915	1000 - 0.25	-100.5@200Kbps -108@50Kbps	9.48@DC/DC	+20				83.36@19.14 dBm,DC/DC	QFN 64
A91S46FZ20PAQ8G	ARM® Cortex®-M4	1536 KB Flash	80KB	21	I2C, SPI, UARTx3, PWMx8	8Ch, 12bit ; RSSI, 8bit	4FSK/FSK/GFSK/4GFSK/OOK	169 - 915	1000 - 0.25	-100.5@200Kbps -108@50Kbps	9.48@DC/DC	+20				83.36@19.14 dBm,DC/DC	QFN 64
A9136M4	Sub1GHz TRX																
A91S36F920PAQ6C	ARM® Cortex®-M4	512 KB Flash	80KB	13	I2C, UARTx3, PWMx4	4Ch, 12bit ; RSSI, 8bit	4FSK/FSK/GFSK/4GFSK/OOK	169 - 915	1000 - 0.25	-100@200Kbps -107@50Kbps	9.48@DC/DC	+20				83.36@19.14 dBm,DC/DC	QFN 48
A91S36FZ20PAQ6C	ARM® Cortex®-M4	1536 KB Flash	80KB	13	I2C, UARTx3, PWMx4	4Ch, 12bit ; RSSI, 8bit	4FSK/FSK/GFSK/4GFSK/OOK	169 - 915	1000 - 0.25	-100@200Kbps -107@50Kbps	9.48@DC/DC	+20				83.36@19.14 dBm,DC/DC	QFN 48
A9139	Sub1GHz TRX																
A91U39F6001AQ6C	8051 CPU	64 KB Flash	8KB	32	I2C, SPI, UARTx2, PWMx4	8Ch, 12bit ; RSSI, 8bit	FSK/GFSK	315 - 915	500 - 2	-108@100Kbps	6.9	+20				88.6@19.9dBm	QFN 48
A91X39F4001AQ6C	8051 CPU	16 KB Flash	4KB	32	I2C, SPI, UART, PWMx2	8Ch, 12bit ; RSSI, 8bit	FSK/GFSK	315 - 915	250 - 2	-117@2Kbps	4.5	+20				72.4@19dBm	QFN 48
A91U39F710NAQ5A	ARM® Cortex®-M0	128 KB Flash	16KB	22	I2C, SPI, UARTx2, PWMx2	8Ch, 12bit ; RSSI, 8bit	FSK/GFSK	315 - 915	2000 - 2	-118@2Kbps	4.19@DC/DC	+20				91.7@20dBm, DC/DC	QFN 40
A9129	Sub1GHz TRX																
A91U29F6001AQ6C	8051 CPU	64 KB Flash	8KB	32	I2C, SPI, UARTx2, PWMx4	8Ch, 12bit ; RSSI, 8bit	FSK/GFSK	315 - 915	500 - 2	-108@100Kbps	6.8	+10		31			QFN 48
A91X29F4001AQ6C	8051 CPU	16 KB Flash	4KB	32	I2C, SPI, UART, PWMx2	8Ch, 12bit ; RSSI, 8bit	FSK/GFSK	315 - 915	250 - 2	-117@2Kbps	4.8	+13		22.3			QFN 48
A91U29F710NAQ5A	ARM® Cortex®-M0	128 KB Flash	16KB	22	I2C, SPI, UARTx2, PWMx2	8Ch, 12bit ; RSSI, 8bit	FSK/GFSK	315 - 915	2000 - 2	-118@2Kbps	4.6@DC/DC	+10		15.3@DC/DC			QFN 40
A9339	Sub1GHz TX																
A93X39F4001AQ45	8051 CPU	16 KB Flash	1KB	8	SPI, UART, PWMx2	2Ch, 12bit	FSK/GFSK	315 - 915	250 - 2	-	-	20				76.8@18dBm	QFN 20

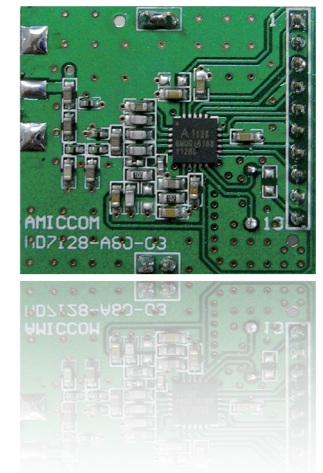

Sub1GHz module.

## 5.8GHz / 5.2GHz Proprietary TRX

PART NUMBER	TYPE	MODULATION	FREQUENCY (MHZ)	DATA RATE (kbps)	SENSITIVITY (dBm)	RX CURRENT (mA)	OUTPUT POWER (Max dBm)	TX CURRENT(dBm)			Package
								+0	+3 mA	+15	
A5133	TRX	FSK	5725 - 5850	4000 -500	-91@4Mbps	33	+15			88	QFN 24

## 5.8GHz SOC

PART NUMBER	Type	Code Memory	RAM	Digital I/O	Peripheral	ADC	MODULATION	DATA RATE (kbps)	SENSITIVITY (dBm)	RX CURRENT (mA)	OUTPUT POWER (Max dBm)	TX CURRENT(dBm)			Package
												+0	+3 mA	+10	
A1011	5.8GHz CPC SoC														
A10U11F6001AQ6C	8051 CPU	64 KB Flash	8K	24	I2C, SPI, UART, ISO7816, PWMx4	8Ch, 8bit ; RSSI, 8bit	ASK	256	-85	32	+9			50@9dBm	QFN 48
A6133M4	5.8GHz SoC														
A61S33F920PAQ7E	ARM® Cortex®-M4	512 KB Flash	80K	24	I2C, SPI, UARTx3, PWMx8	8Ch, 12bit ; RSSI, 8bit	FSK	4000 - 500	91@4Mbps	33	+15			88@15dBm	QFN 56

## Wireless Audio / Voice SoC

PART NUMBER	Type	Code Memory	RAM	Digital I/O	Peripheral	ADC	Audio Codec	MODULATION	FREQUENCY (MHZ)	DATA RATE (kbps)	SENSITIVITY (dBm)	RX CURRENT (mA)	OUTPUT POWER (Max dBm)	TX Currnet (mA)	Package
A81X01F4000AQ6C	8051 CPU	16KB Flash	512B	24	I2C, SPI, UART, PWMx2	4Ch, 8bit ; RSSI, 8bit	16 bits 16KSps	FSK/GFSK	2400 - 2483.5	2000 - 500	-88@2Mbps	24.2	+20	156@20dBm	QFN 48
A81X01F4003AQ58	8051 CPU	16KB Flash	512B	8	UART	2Ch, 8bit ; RSSI, 8bit	16 bits 16KSps	FSK/GFSK	2400 - 2483.5	2000 - 500	-88@2Mbps	24.2	+20	156@20dBm	QFN 32
A8102	Wireless Audio SoC														
A81X02F5002AQ7E	8051 CPU	32KB Flash	8.5KB	22	USB, I2S, I2C, SPI, UART, PWMx2	4Ch, 8bit ; RSSI, 8bit	Stereo 16 bits 48KSps	FSK/GFSK	2400 - 2483.5	4000	-85@4Mbps	32	+17	120@17dBm	QFN 56
A8103	Wireless Audio SoC														
A81X03F4001AQ6C	8051 CPU	16KB Flash	1K	24	I2C, SPI, UART, PWMx4	8Ch, 8bit ; RSSI, 8bit	16 bits 32KSps	FSK/GFSK	2400 - 2483.5	2000 - 500	-90@2Mbps	32.5	+22	240@22dBm	QFN 48
A9101	Wireless Audio SoC														
A91X01F4001AQ6C	8051 CPU	16KB Flash	512B	24	I2C, SPI, UART, PWMx2	RSSI, 8bit	16 bits 32KSps	FSK/GFSK	315 - 915	2000 - 500	-94@500Kbps @915MHz	16	+17	79@17dBm	QFN 48

## Zigbee/ RF4CE /IEEE 802.15.4

PART NUMBER	Type	Code Memory	RAM	Digital I/O	Peripheral	ADC	MODULATION	FREQUENCY (MHZ)	DATA RATE (Max kbps)	SENSITIVITY (dBm)	RX CURRENT (mA)	OUTPUT POWER (Max dBm)	TX CURRENT(dBm)		Package
													Normal	Max. mA	
A8153	IEEE802.15.4 SoC														
A81X53F5000AQ5A	8051 CPU	32KB Flash	2KB	24	I2C, SPI, UART, PWMx2	4Ch, 8bit; RSSI, 8bit	DSSS/MSK	2405 - 2480	250	-96@250Kbps	19.8	+3.5	14.8@0dBm	19.8@3.5dbm	QFN 40

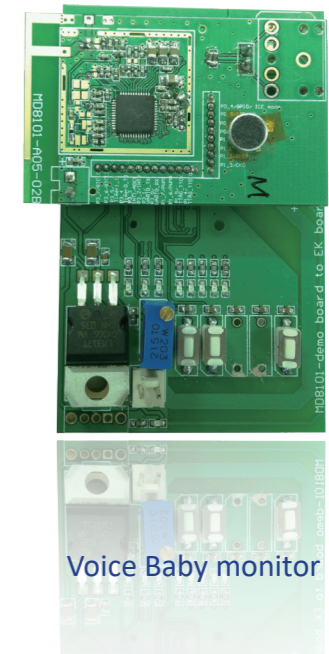

Voice Baby monitor

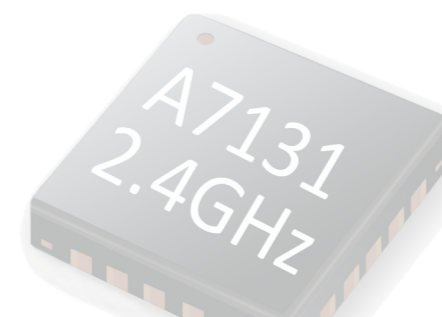

## Bluetooth Low Energy

PART NUMBER	Type	Code Memory	RAM	Digital I/O	Peripheral	ADC	MODULATION	DATA RATE (kbps)	SENSITIVITY (dBm)	RX CURRENT (mA)	OUTPUT POWER (Max dBm)	TX CURRENT(dBm)		Package
												Normal	Max.	
A7107	Bluetooth Low Energy TRX	-	-	-	-	RSSI, 8bit	1Mbps GFSK	2000 - 500	-90@1Mbps	17	+8	17@2dBm	24.5@8dBm	QFN 32
A8105	Bluetooth Low Energy SoC													
A81X05F5009AQ6C	8051 CPU	32KB Flash	2KB	28	I2C, SPI, UART, PWMx2	8Ch, 12bit ; RSSI, 8bit	1Mbps GFSK	2000 - 500	-92@1Mbps	16.3	+6	15.2@0dBm	20.2@6dBm	QFN 48
A81X05F5001AQ5A	8051 CPU	32KB Flash	2KB	24	I2C, SPI, UART, PWMx2	8Ch, 12bit; RSSI, 8bit	1Mbps GFSK	2000 - 500	-92@1Mbps	16.3	+6	15.2@0dBm	20.2@6dBm	QFN 40
A81U05F600BAQ6C	8051 CPU	64KB Flash	8KB	32	I2C, SPI, UART, PWMx4	8Ch, 12bit; RSSI, 8bit	1Mbps GFSK	2000 - 5	-94@1Mbps	11.5	+7	12.5@0dBm	16.5@5dBm	QFN 48
A81U05F6001AQ5A	8051 CPU	64KB Flash	8KB	24	I2C, SPI, UART, PWMx4	8Ch, 12bit; RSSI, 8bit	1Mbps GFSK	2000 - 5	-94@1Mbps	11.5	+7	12.5@0dBm	16.5@5dBm	QFN 40
A8115	Bluetooth Low Energy SoC with Voice ADC													
A81U15F600BAQ6C	8051 CPU	64KB Flash	8KB	32	I2C, SPI, UART, PWMx4, Micx1	8Ch, 12bit; RSSI, 8bit	1Mbps GFSK	2000 - 5	-94@1Mbps	11.5	+7	12.5@0dBm	21@7dBm	QFN 48
A81U15F6001AQ5A	8051 CPU	64KB Flash	8KB	24	I2C, SPI, UART, PWMx4, Micx1	8Ch, 12bit; RSSI, 8bit	1Mbps GFSK	2000 - 5	-94@1Mbps	11.5	+7	12.5@0dBm	21@7dBm	QFN 40
A8107	Bluetooth Low Energy SoC													
A81X07F600BAQ6C	8051 CPU	64KB Flash	8KB	32	I2C, SPI, UART, PWMx4	8Ch, 12bit ; RSSI, 8bit	1Mbps GFSK	2000 - 500	-92@1Mbps	15.9	+6	16@0dBm	21@6dBm	QFN 48
A81X07F6001AQ5A	8051 CPU	64KB Flash	8KB	24	I2C, SPI, UART, PWMx4	8Ch, 12bit; RSSI, 8bit	1Mbps GFSK	2000 - 500	-92@1Mbps	15.9	+6	16@0dBm	21@6dBm	QFN 40
A81X07F700BAQ6C	8051 CPU	128KB Flash	8KB	32	I2C, SPI, UART, PWMx4	8Ch, 12bit ; RSSI, 8bit	1Mbps GFSK	2000 - 500	-92@1Mbps	15.9	+6	16@0dBm	21@6dBm	QFN 48
A81X07F7001AQ5A	8051 CPU	128KB Flash	8KB	24	I2C, SPI, UART, PWMx4	8Ch, 12bit; RSSI, 8bit	1Mbps GFSK	2000 - 500	-92@1Mbps	15.9	+6	16@0dBm	21@6dBm	QFN 40
A8107M0	Bluetooth Low Energy SoC													
A81U07F810GAQ6C	ARM® Cortex®-M0	256KB Flash	32KB	31	I2C, SPI, UARTx3, PWMx4, i86 interface with DMA	8 Ch, 12bit	GMSK/GFSK	2000 - 5	-94@1Mbps	6.4@DC/DC	+6	9.0@5dBm @DC/DC		QFN 48
A81U07F8102AQ5A	ARM® Cortex®-M0	256KB Flash	32KB	23	I2C, SPI, UARTx2, PWMx4, i86 interface with DMA	5Ch, 12bit	GMSK/GFSK	2000 - 5	-94@1Mbps	6.4@DC/DC	+6	9.0@5dBm @DC/DC		QFN 40
A3107M0	Bluetooth Low Energy SoC													
A31U07F810GAQ6C	ARM® Cortex®-M0	256KB Flash	32KB	31	I2C, SPI, UARTx3, PWMx4, i86 interface with DMA	8 Ch, 12bit	GMSK/GFSK	2000 - 5	-94@1Mbps	6.4@DC/DC	+6	9.0@5dBm @DC/DC		QFN 48
A31U07F8102AQ5A	ARM® Cortex®-M0	256KB Flash	32KB	23	I2C, SPI, UARTx2, PWMx4, i86 interface with DMA	5Ch, 12bit	GMSK/GFSK	2000 - 5	-94@1Mbps	6.4@DC/DC	+6	9.0@5dBm @DC/DC		QFN 40
A3117M0	Bluetooth Low Energy SoC													
A31U17F8101AQ5A	ARM® Cortex®-M0	256KB Flash	72KB	23	I2C, SPI, UARTx2, PWMx4, 48M speed CPU i86 interface with DMA	5Ch, 12bit	GMSK/GFSK	2000 - 5	-94@1Mbps	6.4@DC/DC	+6	9.0@5dBm @DC/DC		QFN 40
A31U17F8102AQ6C	ARM® Cortex®-M0	256KB Flash	72KB	31	I2C, SPI, UARTx3, PWMx4, 48M speed CPU i86 interface with DMA	8Ch, 12bit	GMSK/GFSK	2000 - 5	-94@1Mbps	6.4@DC/DC	+6	9.0@5dBm @DC/DC		QFN 48
A31U17F8105AQ6C	ARM® Cortex®-M0	256KB Flash	72KB	26	I2C, SPI, UARTx3, PWMx4, 48M speed CPU i86 interface with DMA,USB	6Ch, 12bit	GMSK/GFSK	2000 - 5	-94@1Mbps	6.4@DC/DC	+6	9.0@5dBm @DC/DC		QFN 48
A31U17F8106AQ7E	ARM® Cortex®-M0	256KB Flash	72KB	32	I2C, SPI, UARTx3, PWMx4, 48M speed CPU i86 interface with DMA,USB	8Ch, 12bit	GMSK/GFSK	2000 - 5	-94@1Mbps	6.4@DC/DC	+6	9.0@5dBm @DC/DC		QFN 56
A3513/A3512/A3113	Bluetooth Low Energy SoC with 24bit SDADC and LCD driver													
A3513 A35U13F6001AQ7E	8051 CPU	64KB Flash	8KB	26	I2C, SPI, UART, PWMx3 TN LCD driver (4x21)	4Ch, 24bit SDADC (ENOB 20bit); 6Ch, 12bit; RSSI, 8bit	1Mbps GFSK	2000 - 5	-93@1Mbps	11.9	+5		17.2@5dBm	QFN 56
A3512 A35U12F6001AQ6C	8051 CPU	64KB Flash	8KB	22	I2C, SPI, UART, PWMx2 TN LCD driver (4x15)	3Ch, 24bit SDADC (ENOB 20bit); 4Ch, 12bit; RSSI, 8bit	1Mbps GFSK	2000 - 5	-93@1Mbps	11.9	+5		17.2@5dBm	QFN 48
A3113 A31U13F6001AQ5A	8051 CPU	64KB Flash	8KB	21	I2C, SPI, UART, PWMx3	3Ch, 24bit SDADC (ENOB 20bit); 4Ch, 12bit; RSSI, 8bit	1Mbps GFSK	2000 - 5	-93@1Mbps	11.9	+5		17.2@5dBm	QFN 40

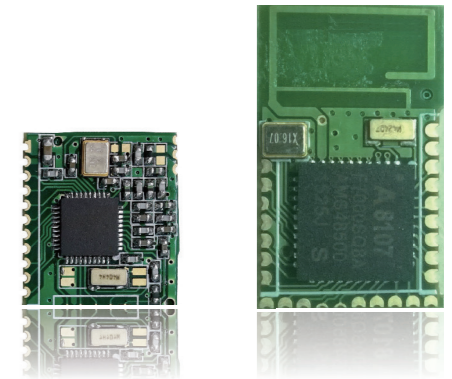

Bluetooth Low Energy module

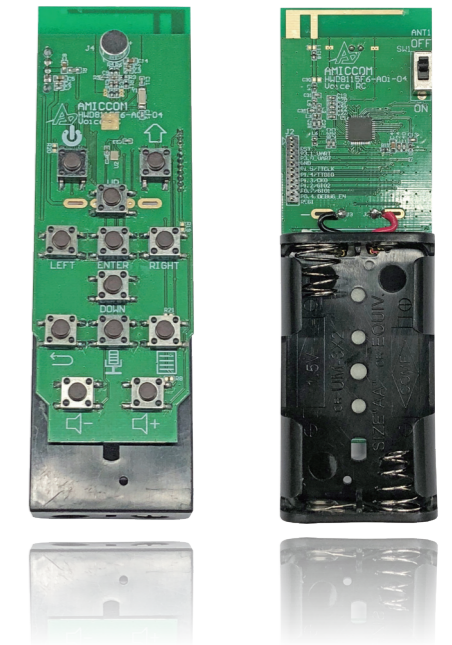

BLE with Voice

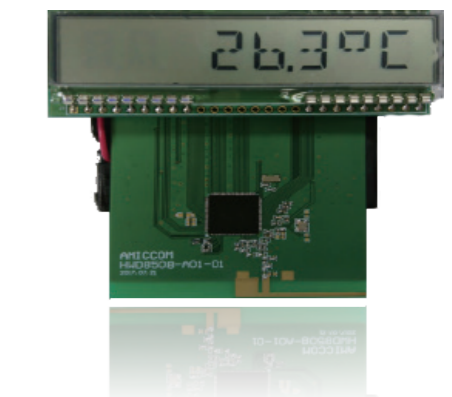

BLE with LCD

除了 ISM Band RF IC，笙科電子自成立以來，就以 CMOS 技術設計 LNB IC，至今該產品已經順利量產多年，深獲客戶長期信任。並於近年來研發 LNB Down-Converter 整合 PLL 與 VCO，並可直接驅動 pHENT 偏壓。

In addition to the ISM Band RF IC, AMICCOM has designed LNB Switch ICs based on CMOS technology. So far, this product line has been mass-produced many years and has won long-term trust from customers. In recent years, LNB Down-Converter has been developed to integrate PLL and VCO, and can directly drive pHENT bias.

笙科電子針對衛星通訊，提供兩大產品選擇 - LNB Switch 與 LNB Down-Converter。笙科電子運用台灣充分的半導體產業資源，提供了一個低價位以及高效能的選擇，針對全球衛星通訊設備製造廠商，提供完整的技術服務，包括線路設計以及解決系統應用問題，大大縮短客戶的開發時程，配合測試流程的簡化，更容易讓成品導入量產。

AMICCOM provides two types of products for satellite communications: LNB Switch and LNB Down-Converter. AMICCOM takes advantage of Taiwan's semiconductor industry resources to provide a low-cost and high-performance product for global satellite communications equipment manufacturers. We provide complete technical services, includes circuit design and system application, which greatly shorten the development schedule and simplify the test process for customers, and make the prototype products be imported into mass production easier.

## Satellite Switch

PART NUMBER	Function	FREQUENCY (MHZ)	Isolation (Typical dB)	Insection lose (Typical dB)	Others	Package
A7524	2x4 SWITCH	950 - 2150	28	4	Polarity detector	QFN 24
A7542	4x2 SWITCH	250 - 2150	40	7.5	Logic input	QFN 24
A7533	4x2 SWITCH	250 - 2150	31	7.5	Polarity detector Tone detector	QFN 20
A7535	4x2 SWITCH	250 - 2150	31	7.5	Polarity detector Tone detector	QFN 24
A7539	4x2 SWITCH	250 - 2150	40	7.5	Logic input	QFN 24
A7540	4x2 SWITCH	250 - 2150	40	7.5	Polarity detector Tone detector	QFN 24
A7544	4x4 SWITCH	250 - 2150	28	12	Polarity detector Tone detector	QFN 24

## Satellite PLO Down-Converter

PART NUMBER	Function	FREQUENCY (GHZ)	LO FREQUENCY (GHz)	Crystal (MHz)	Others	Package
A7832	C band single LNB	3.4 - 4.2	5.15	25	FET Bias Polarity detector Tone detector	QFN 32

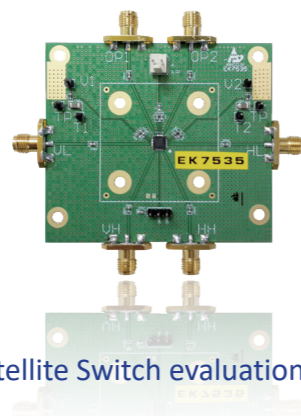

Satellite Switch evaluation kit

笙科提供完整的開發工具供客戶快速導入開發並在量產端提供簡便的量產治具供快速量產。開發階段可使用 EK (Evaluation kit ) board 並配合各頻段的無線射頻 IC，如下圖 EK 7105. EK Board 提供 USB connector 與電腦連線。在電腦端提供應用程式如下圖 EK7105-G2。客戶可以快速驗證 RF 特性或是開發程式進行傳輸資料驗證。

AMICCOM provides complete development tools for customers to quickly develop and provide simple test fixtures for mass-production. During the development phase, EK (Evaluation kit) board can be used with the radio frequency IC, for example, shown in the figure below is EK 7105. EK Board provides a USB connector to connect with a computer. Graphic user interface program is provided for application on computer as shown in the figure EK7105-G2. Customers can quickly explore the RF characteristics and develop programs to verify data transmission.

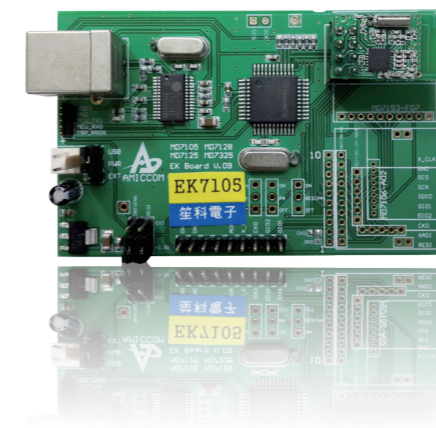

EK 7105

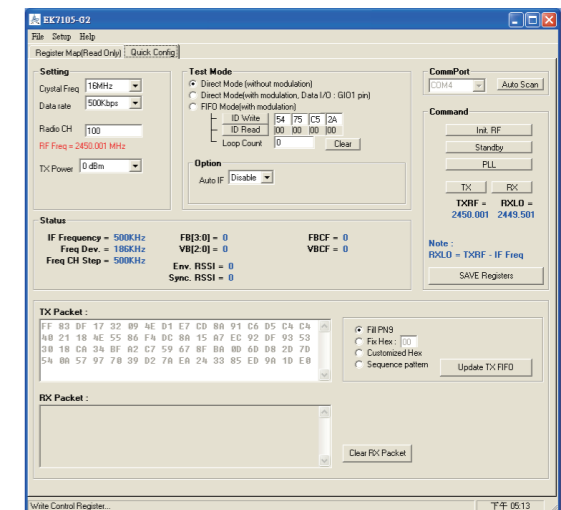

EK7105-G2

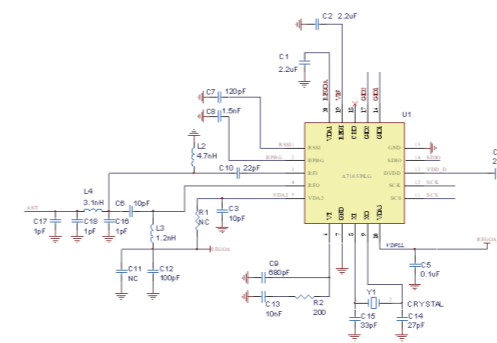

Reference circuit

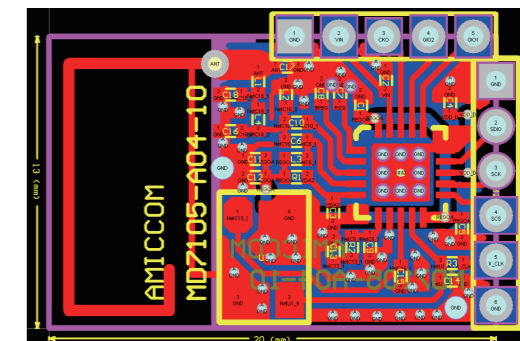

Reference Layout

在 SoC 產品的開發上，笙科電子提供 DVP (Development) board 供客戶開發。DVP board 上有 Button 與 LED 供 I/O 輸出入。在量產上，笙科提供 1 對 1、1 對 4 與 1 對 8 的燒錄器，可減少大量燒錄時間。

For the development of SOC products, AMICCOM provides DVP (Development) board for system development. There are Buttons and LEDs on the DVP board for Input/Output. For SOC mass production, AMICCOM provides 1-to-1, 1-to-4, and 1-to-8 Writer, which can reduce a lot of programming time.

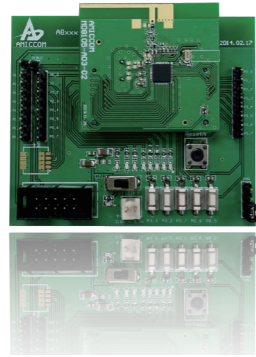

DVP



ICE\_51



Writer 1-to-1

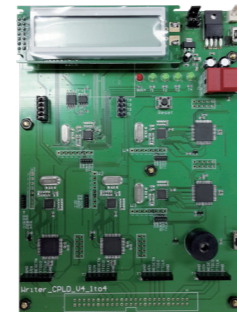

Writer 1-to-4

笙科電子提供價格便宜並可快速量產的 RF 測試治具，客戶可不用投資昂貴的 RF 測試儀器。

AMICCOM provides RF test fixtures that are inexpensive and easily-used in mass-production, so customers do not need to invest in expensive RF test equipment.

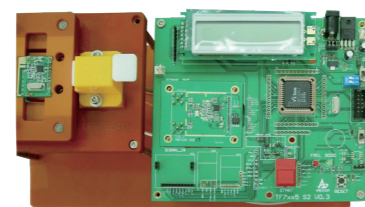

RF Test Fixture



A7108 2012 China ACE Award 年度最佳射頻無線產品獎  
A7108 2012 China ACE Award Best RF Wireless Product of the Year

Deloitte Technology Fast 500 Asia Pacific 2012



A7131 2013 China ACE Award 年度最佳射頻無線產品獎  
A7131 2013 China ACE Award Best RF Wireless Product of the Year

A7129 低接收功耗的無線射頻技術  
2013 EDN China 創新獎的創新技術優秀獎  
Wireless RF technology with low receiving power  
2013 EDN China Innovation Award for Excellence in Innovation Technology



A5130/A5125 2017 China ACE Award 年度最佳 RF 無線 IC  
A5130/A5125 2017 China ACE Award Best RF/Wireless IC of the year

A7157 2021 EDN 亞洲金選獎：年度最具前景產品  
A7157 2021 EDN EE Asia AWARD: The promising Product of the year



A8131M0 2022 EDN 亞洲金選獎：年度最佳 RF 無線 IC  
A8131M0 2022 EDN EE Asia AWARD: Best RF/Wireless IC of the year

A7149 2023 EDN 亞洲金選獎：金選潛力標竿  
A7149 2023 EDN EE Asia AWARD: Most Promising Awards





笙科電子



總公司 Headquarters

Tel : +886-3-5601717

30265 新竹縣竹北市台元街18號10樓  
10F., No.18, Taiyuan St., Zhubei City,  
Hsinchu County 30265, Taiwan, R.O.C.

台北辦公室 Taipei office

11492 臺北市內湖區瑞光路358巷38弄36號7樓  
7F., No.36, Aly. 38, Ln. 358, Ruiguang Rd., Neihu Dist.,  
Taipei City 11492, Taiwan, R.O.C.

深圳辦公室 Shenzhen office

518048 深圳市福田區深南大道6011號NEO大廈A座34B  
34B, NEO Tower A, 6011, Shennan Avenue, Futian District,  
Shenzhen, 518048 China

上海辦公室 Shanghai office

201106 上海市閘行區申濱南路1058號606室  
Room 606, No. 1058, Shenbin South Road, Minhang District,  
Shanghai, 201106 China

<http://www.amiccom.com.tw>

